

# The 5000 series

The POWER amp.  
RB-5000



The CONTROL amp.  
RC-5000

Quality. Uncompromised.

# ROTEL®



## WORK OF ART, FREE FROM ALL RESTRAINTS TO ACHIEVE FINEST AND MOST TRANSPARENT SOUND DEFINITION. PURE ELEGANCE.

The RB-5000 is a powerful amplifier. It can put out a rather incredible big power, which is a definite advantage in realizing very accurate sound reproduction at all listening levels. But the power is only a small indication of the RB-5000's marvelous characteristics.

The RB-5000 is a state-of-the-art product resulted from Rotel's untiring engineering research to create the best. In a true sense, it can be looked upon as a highly sophisticated and complex machine.

The RB-5000 is a pure elegance. No other words may describe it better. The clean, undistorted sound it can reproduce is overwhelmingly impressive. The well-thought electronic circuitry clearly shows a very high-level technology. The formidable-looking front fascia is a sheer joy to watch and touch, also being functionally laid out.

Yet, fundamentally, the RB-5000 is a simple tool for ultimate listening pleasure...

Something to treasure, the RB-5000 power amplifier.

the  
power  
amp  
RB-5000

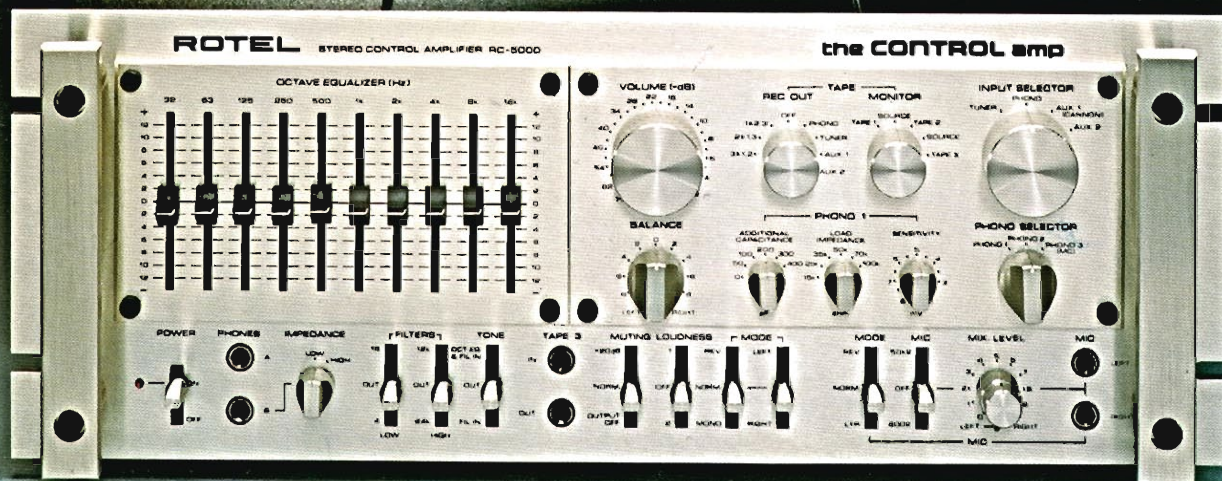

## MUSIC CONTROL CENTER IN HIGHEST FORM, STATE-OF-THE-ART IN HIGH FIDELITY PERFORMANCE. PURE PERFECTION.

The RC-5000 is a control amplifier. It is an extraordinary piece of equipment, considering its very comprehensive features, highly versatile facilities, professional quality performance and extremely polished appearance.

The RC-5000 is also a state-of-the-art product, like the RB-5000 power amplifier its matching partner. The quality of the controls and switches in handling and durability alone will indicate the astounding sophistication of the RC-5000.

The RC-5000 is a dream-comes-true. The most advanced electronic circuits systematically laid out inside its chassis are made up of top-quality long-life materials and components to give consistency in optimum performance. The transparent, faithful musical reproduction it creates is simply fantastic. Especially, a very special attention has been paid to achieve highest possible order of performance in phono playback and tape recording/playback.

To any seasoned audio enthusiast, the RC-5000 will definitely represent a great asset as the workhorse around which a best possible music system can be readily built.

The RC-5000 control amplifier.

the  
control  
amp  
**RC-5000**

# The POWER amp.

RB-5000

## The Power

The RB-5000 delivers a continuous power output of 500 watts per channel, minimum RMS, both channels driven into 8 ohms or 4 ohms from 20 to 20,000Hz with no more than 0.009% total harmonic distortion.

## The DC Configuration

Rotel's advanced amplifier configuration assures constantly stable levels of clean-cut, high-fidelity sound from very small to very large outputs. With the DC configuration, capacitors which tend to affect sound quality adversely are removed from the input signal path and the NF loop, and low frequencies are extended down to the DC range leading to a highly responsive bass. In other words, the DC circuitry gives greatly improved damping factor and phase shift at low frequencies resulting in superior rendering of undistorted bass. To develop the effective and reliable DC circuitry, a problem of DC drifts caused by variations in input signals and supply voltage is completely eliminated by advanced electronic design. The high stabilization of differential amplifiers and the linear balance are also achieved.

## The Perfect Symmetry Design

Essentially, the total circuit configuration of the RB-5000 can be considered as having two identical monaural power amplifiers in one chassis. This is the ultimate design in top class stereo amplifier by eliminating any static and dynamic interferences between the left and right channels. For a further perfection, a completely separate power supply is provided for the relay switching, the peak indicators and the speaker indicators (using a separate—and third—power transformer).

## The Class AB Operation

The Class A operation eliminates switching distortion and crosstalk, resulting in more linear and cleaner performance. However, the Class A is highly inefficient considering the fact that very large electrical current must be always fed and much larger heat sinks required for high heat dissipation. In order to effectively utilize the excellent sound quality of the Class A amplification at low power levels and the efficient low-distortion design of the Class B amplification at high power levels, Rotel have combined both operations and developed the Class AB amplification. Hence, at normal listening levels, usually 1 to 3 watts, you can enjoy the superb sound of the Class A amplification, while at any peak and power levels over 3 watts you are assured of same clean passage of music by the Class B amplification. The transition from the Class A to the B is automatic, so you just sit back and listen to a very faithful sound reproduction at incredibly low distortion.

## The Amplifier Stages

**First Stage (Pre-Driver)**—The cascode pure complementary push-pull differential amplifier is used. The dual-transistors installed are especially selected for low noise and excellent electrical and thermal characteristics, providing a proper operation of the DC amplification. By this circuitry, the distortion caused by the variation of input signal impedance is substantially reduced, and the very high S/N of over 110dB is readily achieved.

### Second Stage (Pre-Driver) —

The cascode symmetrical push-pull differential amplifier is also used in this stage. The complete stability is easily obtained as the result, reducing the thermal variation of the center-point voltage and the DC drifts. In addition, a negligible overall distortion is realized by a strict selection of special low-noise type transistors and other semi-conductors.

**Output Stage**—The Darlington direct-coupled 4-stage linear complete-mirrored parallel push-pull circuitry is used to maintain stable high power level at very low distortion. 4 huge power transistors, each having a perfect matching characteristics and a capability to handle 150 watts, are provided for each channel. This configuration assures the high-linearity operation and eliminates non-linear distortions, as well as warrants ample margin for thermal effect. Since the circuit configuration is completely symmetrical (mirrored), top and bottom and left and right, a very high order of balance is achieved. In effect, this makes the abundant use of NF to obtain low distortion obsolete, as much lower distortion can be achieved—so low, it approaches the measurable limit of instrument—due to extremely outstanding circuit design and well-selected high-quality electrical parts.

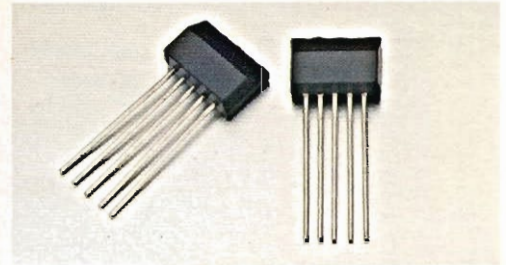

Dual-transistors

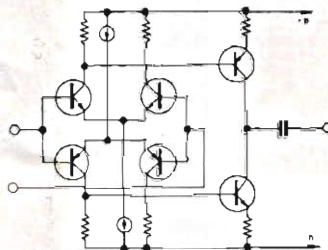

Linear complete-mirrored parallel push-pull circuitry



## BLOCK DIAGRAM

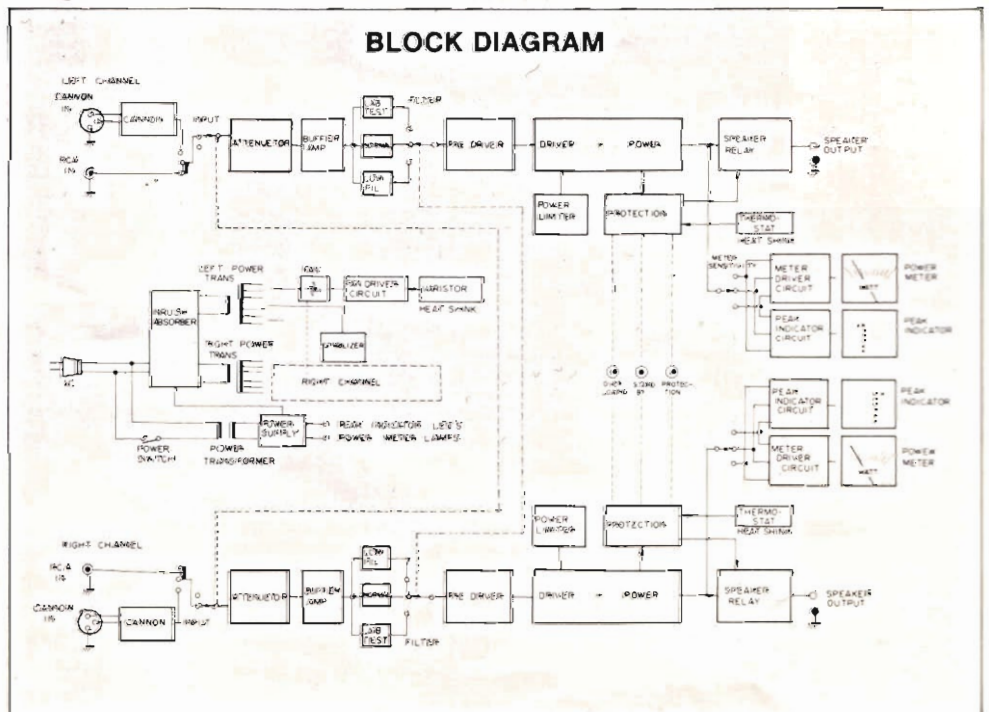

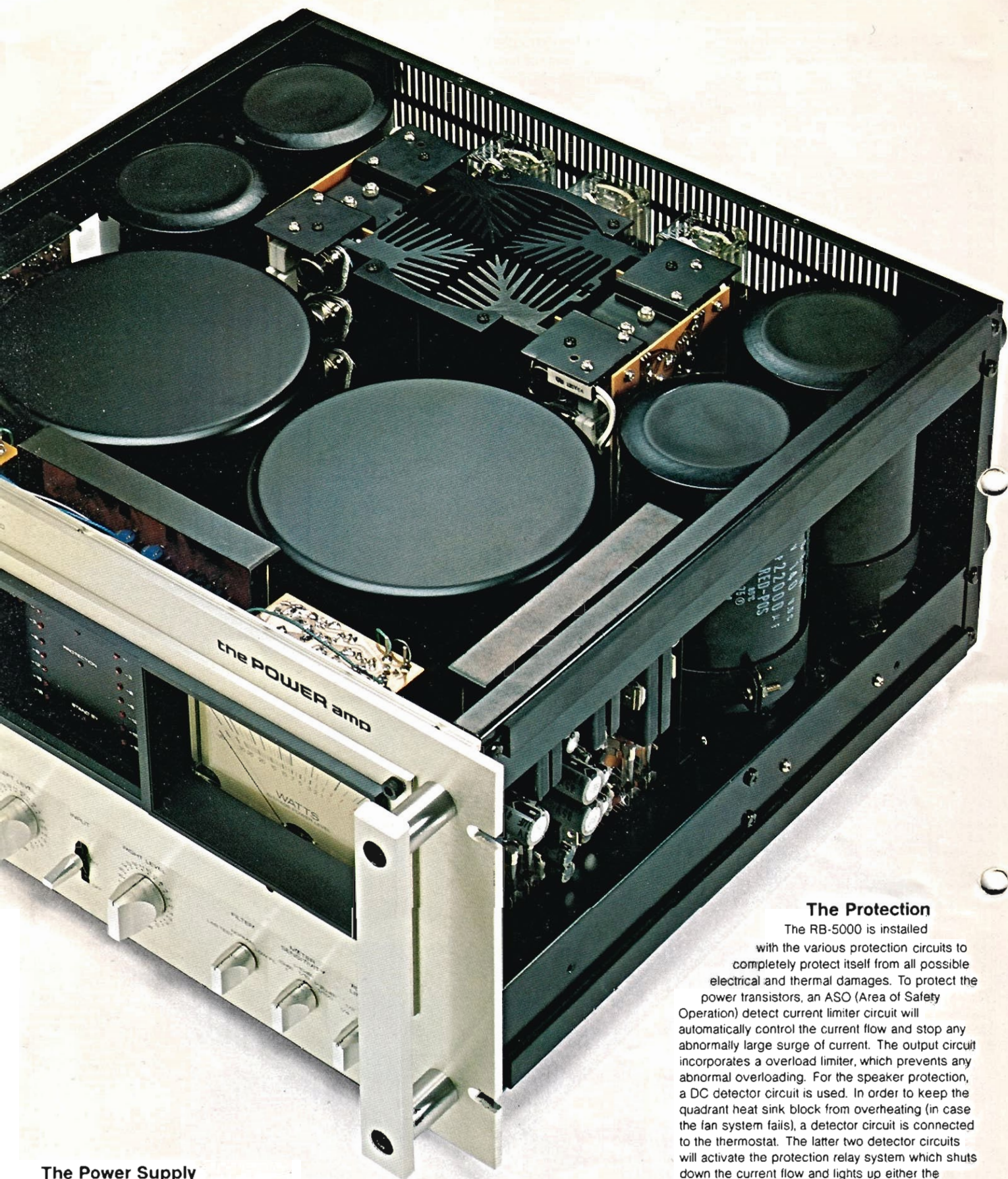

### The Power Supply

Toroidal power transformers not only eliminate such problems as magnetic leakage flux and overheating, but also greatly improve power regulation and transient response. The RB-5000 uses two enormous and high-efficient toroidal power transformers, one for each channel to maintain big power outputs with constant ease. Coupled to each of this transformer are two large cylindrical 22,000 $\mu$ F electrolytic capacitors, (exclusively designed for

the RB-5000 in order to assure a high standard of operation). The third and conventional yet well-constructed power transformer is used to run the relay switchings (protection relays and speaker relays) and LED's (peak indicators and speaker indicators).

### The Protection

The RB-5000 is installed with the various protection circuits to completely protect itself from all possible electrical and thermal damages. To protect the power transistors, an ASO (Area of Safety Operation) detect current limiter circuit will automatically control the current flow and stop any abnormally large surge of current. The output circuit incorporates a overload limiter, which prevents any abnormal overloading. For the speaker protection, a DC detector circuit is used. In order to keep the quadrant heat sink block from overheating (in case the fan system fails), a detector circuit is connected to the thermostat. The latter two detector circuits will activate the protection relay system which shuts down the current flow and lights up either the overload or the protection indicator on the front panel. In addition, to overcome the problems of loud pop-noise and abnormal in-rush current when turning the power switch on, a separate relay and an in-rush current absorber circuit are equipped. Combined with the high quality materials and parts severely selected for reliability and durability, the above protection system offers an incomparable safety operation of the RB-5000.

## The Cooling System

In order to eliminate the problem of overheating by high power output, the RB-5000 incorporates a quadrant-structured heat sink block and an automatically forced air cooling system. The cooling fan module is entirely made of moulded plastic, except for the specially-designed ball-bearing system. This allows the quietest running operation possible, so you will not be annoyed by a fan noise. The fan system is always activated and its rotational speed is controlled by the thermostat attached to the quadrant heat sink block, which houses the power transistors and is constructed to give efficient heat dissipation.

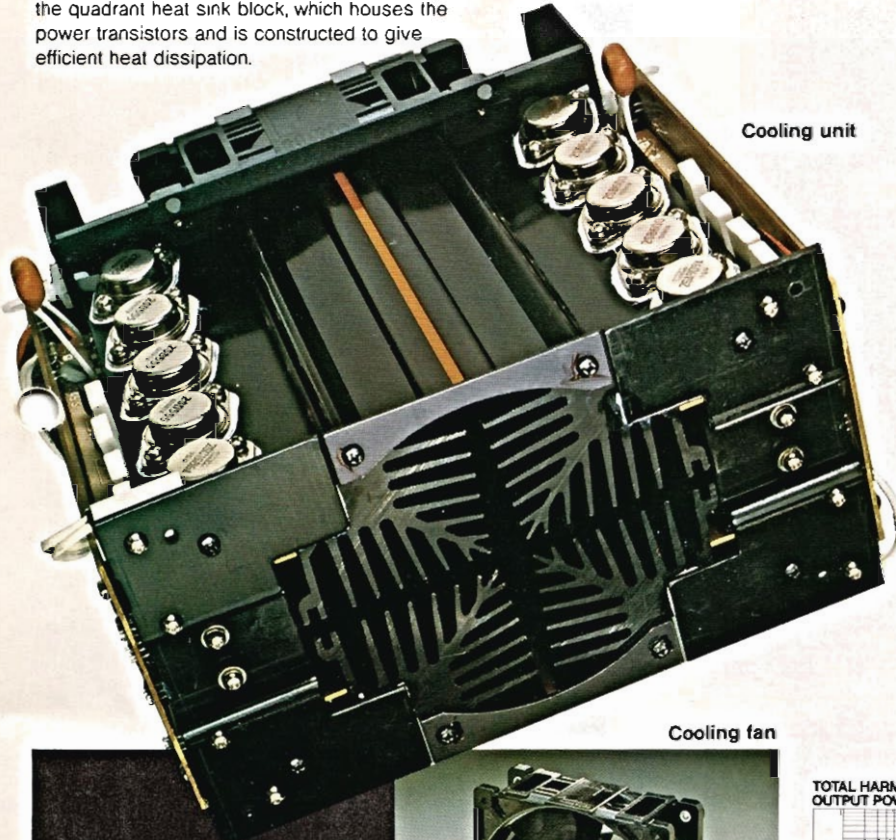

Cooling unit

## The Front Panel Controls

There are three pushbutton switches for three pairs of speaker systems with individual LED indicator. The input ON/OFF switch on the center to cut off input instantaneously. The 22-stepped attenuator-type level controls (from  $-21\text{dB}$  to  $0\text{dB}$  calibrated). The 3-position low frequency filter selector. The 3-position meter sensitivity selector and the 3-position power limiter selector. In other words, all conceivable controls needed to run the RB-5000 effectively and smoothly.

## Cannon sockets and gold-plated RCA jacks



## The Rear Panel Connections

There is the facility for hooking up three pairs of speaker systems. The heavy duty speaker terminals are used for safety sake and to take big-diameter shielded speaker wires. Beside the pair of normal RCA-type input jacks (gold-plated for prevention against corrosion to maintain sound quality), there is also a pair of Cannon sockets for professional studio use. For a convenience, four large plastic legs are installed for servicing.

## The Cosmetic Appearance

The magnificent appearance of the RB-5000 matches the electronic quality it houses. The extruded aluminum front panel is 5mm thick with another layer of aluminum subpanel surrounding the power meters and peak indicators. The knobs used are all solid extruded aluminum for heavy duty use. The RB-5000 is EIA 19-inch rack mountable, and comes with two big aluminum grab handles. For added convenience, two durable casters are installed on rear of the bottom plate so that the unit can be moved readily by rolling on the surface.

Cooling fan

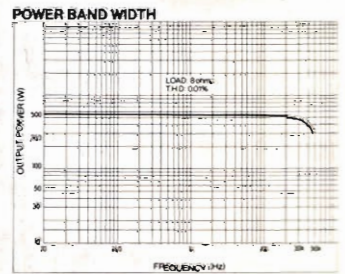
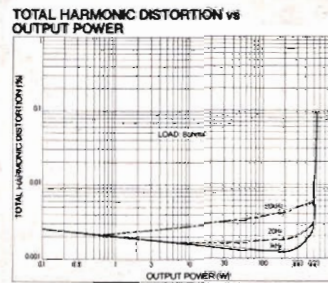
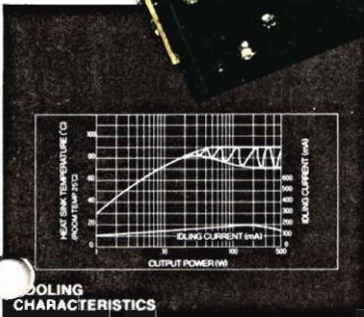

## The Indicators

**Power Meters**—Two big, precision meters give clear visual indication of average power levels in watts and decibels (calibration based on 8-ohm load). The meter sensitivity can be varied by using the 3-position sensitivity selector switch, allowing a very wide visual coverage from 5mW to 1,000W ( $-50\text{dB}$  to  $+3\text{dB}$ ).

**Peak Indicators (LED)**—8 LED's per channel will visually indicate the instantaneous peak levels of power output. When used in conjunction with the power meters, they act as a superb tool for checking setting of level controls.

**Standby Indicator**—This LED lights up when the power switch is turned on, showing that the RB-5000 is on the warm-up stage. It automatically distinguishes when the warm-up time is over.

**The Overload and Protection Indicators**—These LED's light up when the protection system is activated to warn that malfunction has occurred. The overload indicator shows malfunction by overheating in the heat sink block, and the protection indicator implies malfunction by speaker wire shorting or abnormal DC flow.



## OPTIONAL ACCESSORIES

- (a) Professional-quality RCA-type connection cables with gold-plated plugs.
- (b) Professional-type CANNON connection cables.

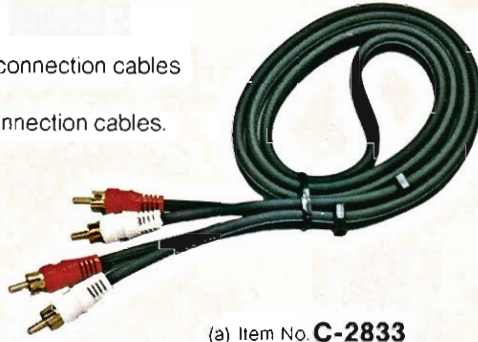

(a) Item No. **C-2833**



(b) Item No. **C-2837**

## SPECIFICATIONS

### Continuous Power Output:

500 watts\* per channel min. RMS both channels driven at 8 ohms or 4 ohms from 20 to 20,000Hz with no more than 0.009% total harmonic distortion.

Total Harmonic Distortion (20 to 20,000Hz)	No more than 0.009% (continuous rated power output) No more than 0.004% (250 watts per channel power output, 8 ohms) No more than 0.006% (1 watt per channel power output, 8 ohms)
Intermodulation Distortion $\pm 1$ dB (70Hz, 7,000Hz = 4:1)	No more than 0.009% (continuous rated power output) No more than 0.004% (250 watts per channel power output, 8 ohms) No more than 0.006% (1 watt per channel power output, 8 ohms)
Frequency Response	LAB DC to 110,000Hz +0dB, -1dB NOR. 15 to 110,000Hz +0dB, -1dB LOW FIL. 20 to 110,000Hz +0dB, -1dB (1 watt per channel power output, 8 ohms)

Input Sensitivity/Impedance	RCA jack IN 1V/50 kohms CANNON jack IN 0.775V/600 ohms
Output Speaker	A, B, C (4-16 ohms); A+B, B+C, A+C (8-16 ohms)
Damping Factor	180 (20 to 20,000Hz, 8 ohms) 350 (1kHz, 8 ohms)
Hum & Noise	120dB (IHF, short-circuited A network)
Crosstalk	70dB/10kHz (reverse channel short)
Power Limiter Output	1/2 8 ohm 300W, 4 ohm 200W 1/4 8 ohm 150W, 4 ohm 100W
Slew Rate	40V/ $\mu$ s
Power Requirements	120V/60Hz or 220V/50Hz or 240V/50Hz or 100, 120, 220, 240V/50-60Hz (switchable)
Power Consumption	1600 watts (8 ohms), 3,200 watts (4 ohms)
Dimensions (Overall)	482(W) x 240(H) x 430(D)mm
Weight (Net)	53kg

NOTE: Specifications and design subject to possible modification without notice.  
\*Measured pursuant to the Federal Trade Commission's Trade Regulation Rule on Power Claims for Amplifiers. (Applicable to the U.S.A. only)

TOTAL HARMONIC DISTORTION vs FREQUENCY

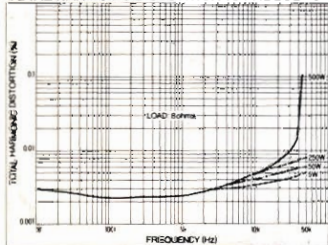

THD DISTORTION vs OUTPUT POWER

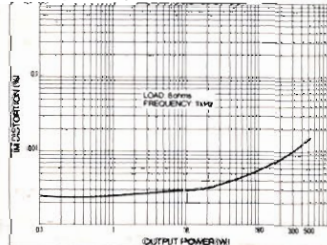

PHASE vs FREQUENCY

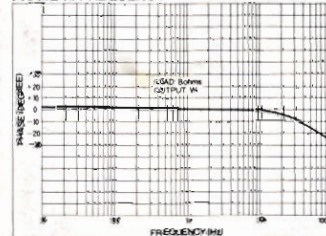

DAMPING FACTOR vs FREQUENCY

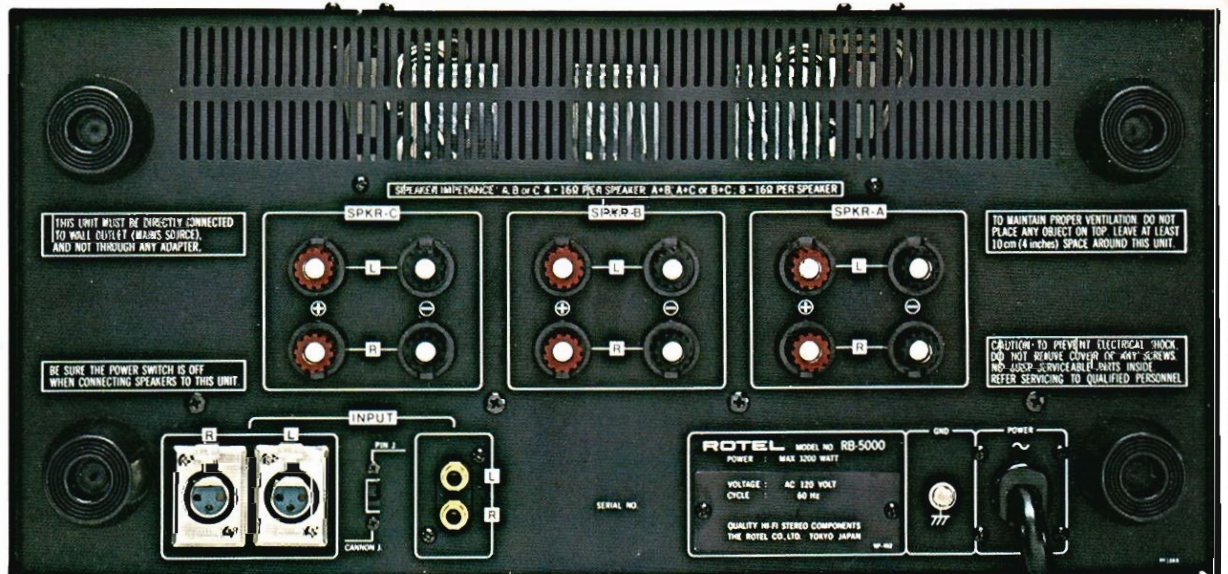
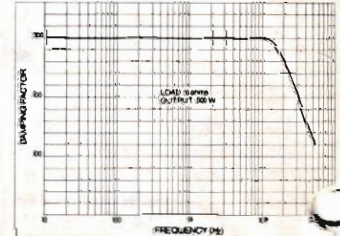

# The CONTROL amp.

## RC-5000

### The Perfect Symmetry Configuration—The Twin-Mono Amplifiers

The RC-5000 in fact is consisted of two identical monaural control amplifiers built onto one chassis. The power supply, the printed circuit board and the components of each amplifier are completely independent and insulated from each others. This is the simple yet ultimate design in professional quality product by eliminating total interferences between the left and the right channels.

### The DC Configuration

The basics and the merits of the DC circuitry have been explained in the previous section for the RB-5000 power amplifier. To provide the highest quality, this advanced configuration is used in each circuit of the RC-5000 to provide the flattest overall characteristic from zero to frequencies well above the highest audible frequency, leaving the user to freely select the shaping and equalization of sound which he requires to suit particular signal and operational needs.

### The Phono Equalizer

This section is made up of a 2-stage DC-connected differential input circuit and a Class A operational output circuit. The first stage of the input circuit incorporates a super-low-noise FET in a cascode-strap configuration, which is highly effective in maintaining high frequency characteristic and holding overall distortion to minimum. The second stage is basically a current loading limiter and constantly suppresses excessive loading to the first stage. The output circuit utilizes the Class A single-end push-pull configuration in order to achieve rock-stable characteristic with no crossover and switching distortions.

As the result, the clean wide-range phono reproduction is easily realized with the S/N ratio more than 80dB (at 2mV input), the overload level exceeding 500mV (at 0.1% THD), and the RIAA curve held within  $\pm 0.2$  dB.

Equalizer amp. circuit diagram

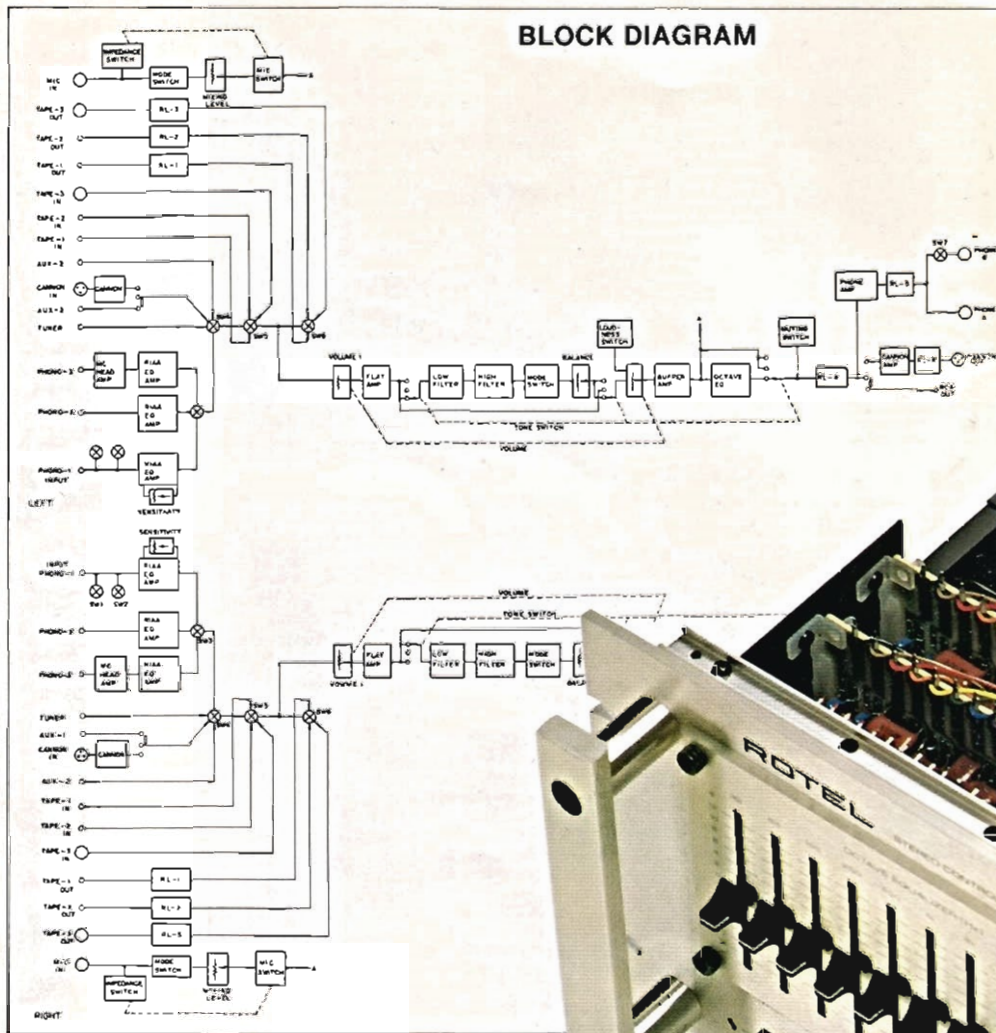
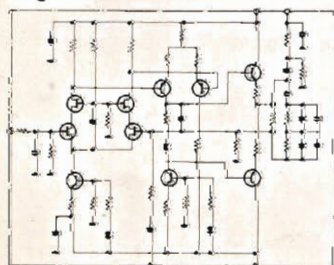

### The MC Head Amplifier

The MC (moving coil) head amplifier built into the RC-5000 uses the DC circuitry without capacitors in the input stages. The entry for signals from the MC cartridge is 2-stage differential circuit which incorporates 4 pairs of super-low-noise transistors in perfect-symmetry configuration. The output stage uses a Class A symmetrical push-pull configuration to eliminate crossover and switching distortions.

With the built-in MC head amplifier, it becomes possible to enjoy music without having to use an external head amplifier or step-up transformer, even with a high performance MC cartridge. Moreover, the well-thought circuitry assures low-noise, low-distortion and wide dynamic range performance.

MC HEAD AMP

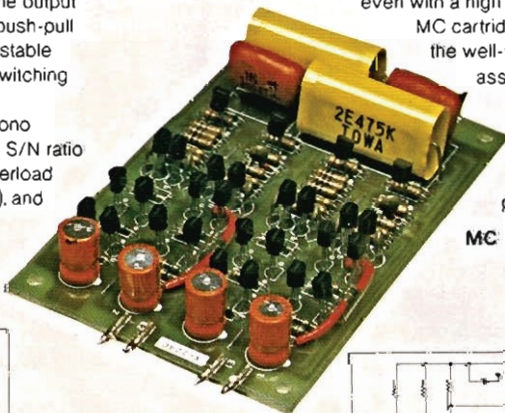

MC head amp circuit diagram

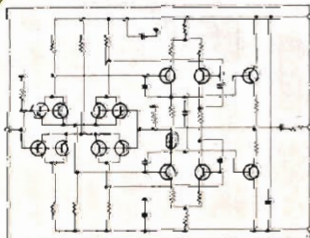

### The Volume Control and The Flat Amplifier

This flat amplifier (tone pre-stage flat amplifier in fact) consists of 2-stage differential cascode-strap input circuit and a Class A single-end push-pull output stage. Since there is no input capacitors, the circuitry is DC-connected. Distortions caused by a variation in signal impedance, crossover and switching are virtually eliminated and very high sound quality is obtained. A precision 4-gang volume control is installed between the input and the output of the flat amplifier (as well as the balance control).

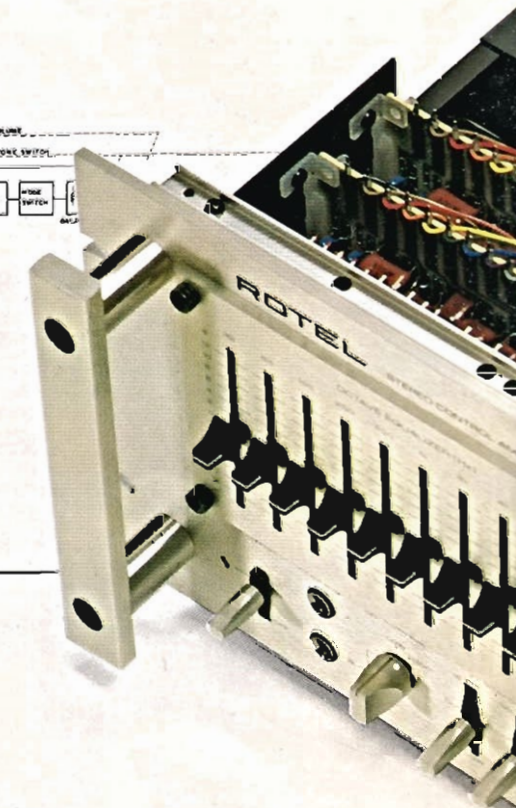
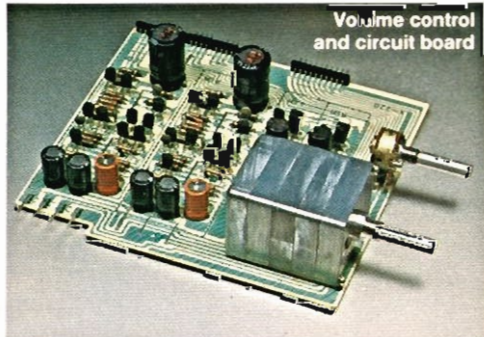



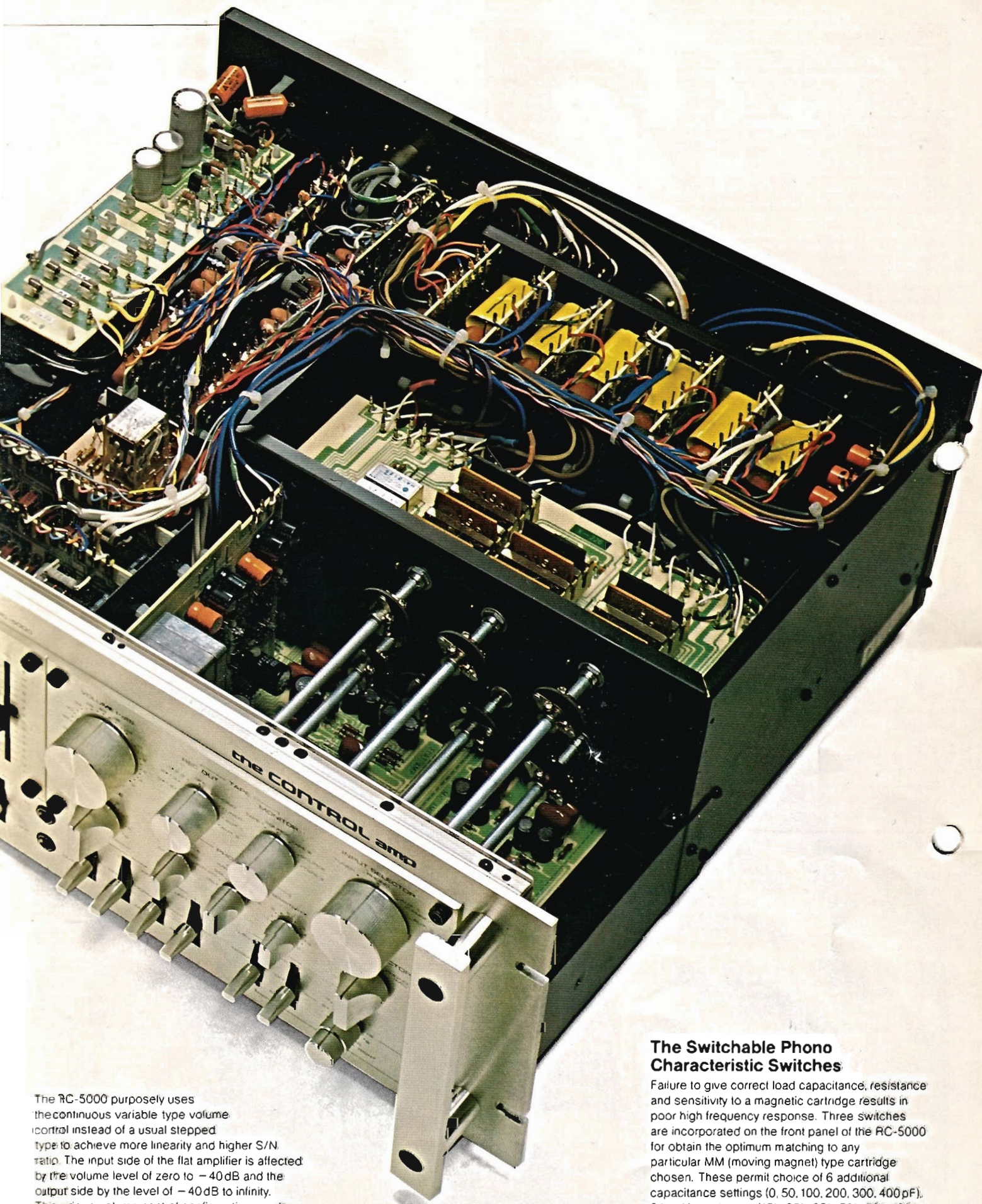

The RC-5000 purposely uses the continuous variable type volume control instead of a usual stepped type to achieve more linearity and higher S/N ratio. The input side of the flat amplifier is affected by the volume level of zero to -40dB and the output side by the level of -40dB to infinity. This unique volume control configuration results in superior characteristic and reduced noise (at the infinity position—minimum level—the residual noise is only 5.6  $\mu$ V).

### The Switchable Phono Characteristic Switches

Failure to give correct load capacitance, resistance and sensitivity to a magnetic cartridge results in poor high frequency response. Three switches are incorporated on the front panel of the RC-5000 for obtain the optimum matching to any particular MM (moving magnet) type cartridge chosen. These permit choice of 6 additional capacitance settings (0, 50, 100, 200, 300, 400pF), 6 load impedances (15k, 25k, 35k, 50k, 70k, 100k), and continuously variable sensitivity level (from 8 to 2 mV). Note the switches are effective for a turntable connected to the PHONO 1 position.

## The Octave Equalizer

Instead of the standard tone control circuit utilizing only bass and treble controls (as well as turnover roll-off switches), the RC-5000 is installed with the octave equalizer. This will give the user more flexibility in improving and expanding original sound components and range, especially useful for room acoustic compensation and high quality tape recording.

The octave equalizer employs a discrete resonant configuration (composed of only transistors, capacitors and resistors instead of commonly used but inferior inductor-coils-system) for its frequency control and vital systems which results in very low distortion and high S/N ratio. The center frequencies are divided into 10, with each band of the particular center frequency adjustable by a slide level control for the  $\pm 12$  dB range. In essence, the whole audible frequency range is effectively covered for maximum adjustable flexibility. A 5-stage direct-coupled circuit with a FET first stage DC-connection assures wide dynamic range and incredibly negligible noise.

## The Low and High Filters

These are  $-12$  dB/octave active filters composed of a 2-stage Darlington direct-coupled configuration with a FET input stage and bi-polar transistors. The two-position switch allows the low filter to be selectable for 15 Hz or 4 Hz setting (both settings are at subsonic frequencies, useful for cutting out unwanted noise effects at very low frequency range). The two selectable positions are also available for the high filter, with the 24 kHz setting useful to avoid unwanted components from the very high frequency range affecting the audible range negatively.

## The Separate Recording Selector Control

The REC OUT control located on the front panel of the RC-5000 makes it possible to choose a signal desired for recording by tape recorder regardless of the input source one may be listening to. For instance, this makes possible the recording from turntable while listening to FM broadcast. The full tape dubbing between two tape recorders (or between one recorder and two other recorders) is also controlled by the REC OUT control, regardless of what is being played through the control amplifier.

## The Microphone Amplifier

2 high quality IC's and super-low-noise FET are used on each channel of this amplifier to ensure large overload characteristic and improve S/N ratio. The high quality concentric level controls are incorporated for the smooth mic mixing, along with the 2-position mic impedance selector and the 3-position mode selector. Hence, a high-fidelity recording is possible with this professional-caliber mic amplifier.

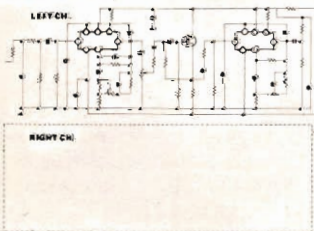

Microphone amp circuit diagram

## The Power Supply

The highly stable dual power supply circuit using two specially designed power transformers (for independent supply to the left and the right channels) assures excellent regulation and clean

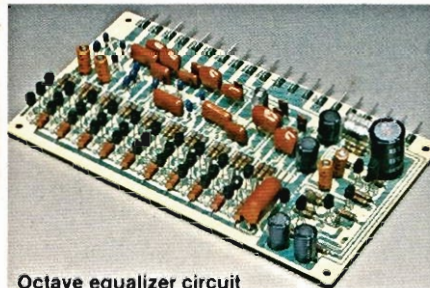

Octave equalizer circuit

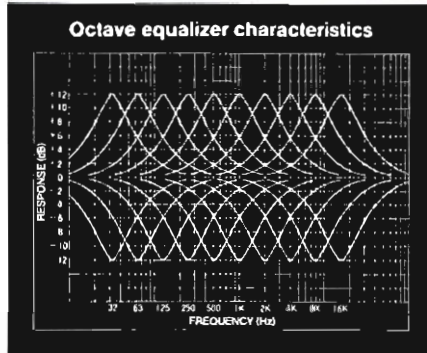

response. Moreover, a third separate power transformer is built-in to supply power independently to the headphone amplifier and the relay system.

## The Cannon Type Input/Output Terminals

On the rear panel of the RC-5000, one pair each of the Cannon input and output sockets are equipped for the professional usage such as by broadcasting studio. The input has 600-ohm balanced impedance with one buffer amplifier/one-stage differential amplifier/3-stage direct-coupled circuit to maintain interference-free high quality characteristic. The output is also the 600-ohm balanced impedance type with 3-stage

direct-coupled, 1-stage differential amplifier, Class A single-end push-pull circuit to prevent crossover and switching distortions affect high performance characteristic.

## The Facilities

The RC-5000 is endowed with the complete facilities, such as the connection for up to three tape recorders and the full dubbing feasibility among these tape decks; the connection for up to three turntables (one exclusively for the MC cartridge use) with the front panel switchable loading selector switches to perfectly match characteristics of particular MM type cartridge used for PHONO 1; the connection for two auxiliary equipments, with one switchable to become the Cannon input/output terminals to accept professional-use component; the connection for the stereo mics with own mixing level control, impedance selector and mode selector; the connection for two stereo headphone sets with 2-position-impedance selector switch for PHONES B; the octave equalizer section with 10 slide level controls, as well as the tone cut switch to deactivate the equalizer together with or without the low and high filters; and the convenient switches such as 2-position muting switch, 2-position loudness switch, 5-position dual mode switches. In addition, all RCA type jacks on the rear panel are gold-plated for prevention against corrosion to adversely affect sound quality.

## The Cosmetic Appearance

The grand appearance of the RC-5000 not only matches the quality electronics it houses, but also the RB-5000 its perfect partner. The extruded aluminum panel is 5 mm thick with two subpanels overlaid (one displaying octave equalizer section and the other the main controls). The knobs used are all solid extruded aluminum, except the octave equalizer slide control knobs which are heavy-duty plastic molds. The RC-5000 is EIA 19-inch rack mountable, and comes with two big aluminum grab handles.

PHONO EQUALIZER CHARACTERISTICS (PHONO-3/MC)

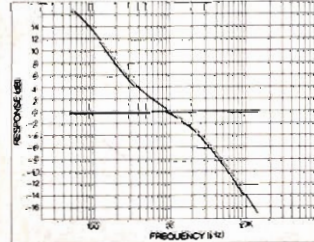

PHONO INPUT LEVEL vs OUTPUT DISTORTION

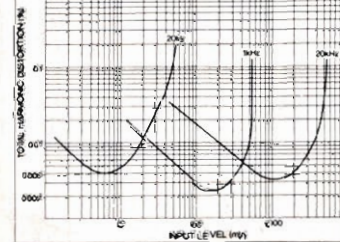

PHONO (MM) OUTPUT vs TOTAL HARMONIC DISTORTION

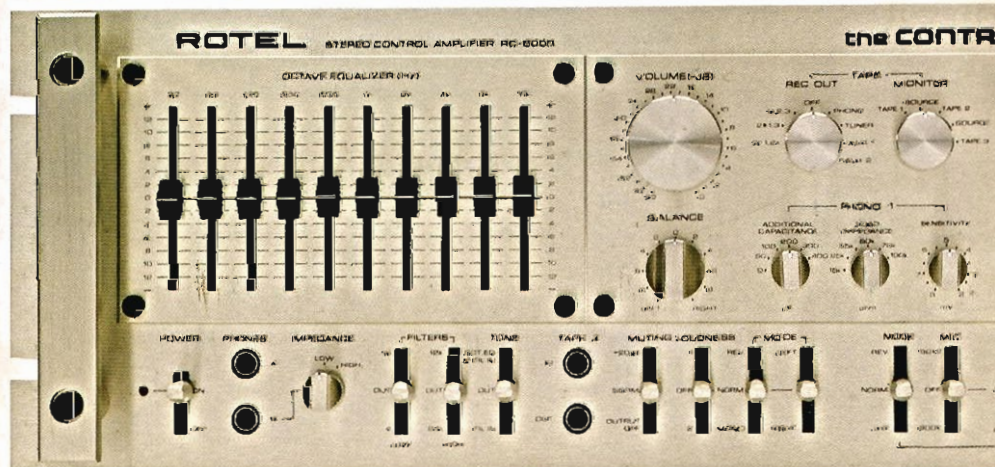
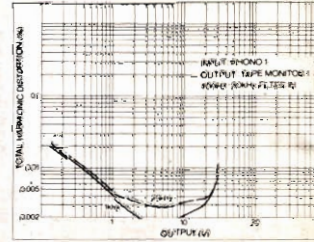

# SPECIFICATIONS

## EQUALIZER AMPLIFIER SECTION

Output Voltage/Impedance (at 1kHz)

Rated Output DIN output

50mV ..... 150mV

Max. Output 0.5% T.H.D. .... 30V

Harmonic Distortion (5V output 20 to 20,000Hz)

PHONO 1, 2 (MAG) ..... 0.003%

PHONO 3 (MC) ..... 0.004%

Phono Equalization (20 to 20,000Hz)

PHONO 1 RIAA STD ..... ±0.2dB

PHONO 2, 3 RIAA STD ..... ±0.2dB

Hum and Noise (IHF A network, 1V output)

PHONO 1, 2 (MAG) ..... 80dB

PHONO 3 (MC) ..... 70dB

Input Sensitivity/Impedance (ref. rated output)

PHONO 1 (MAG) ..... ±1dB 2~8mV/15, 25, 35, 50, 70, 100 kohms  
0, 50, 100, 200, 300, 400pF

PHONO 2 (MAG) ..... ±1dB 2mV/50 kohms

PHONO 3 (MC) ..... ±1dB 90µV/22 ohms

Crosstalk (at 20,000Hz, reverse channel short) ..... 50dB

Over Load (1kHz, 0.5% T.H.D.)

PHONO 1 (MAG) ..... 500~2000mV

PHONO 2 (MAG) ..... 500mV

PHONO 3 (MC) ..... 20mV

Intermodulation Distortion (70Hz: 7kHz = 4:1) ..... 0.009%

## PRE AMPLIFIER SECTION (AT PRE-OUTPUT)

Output Voltage/Impedance

RCA JACK rated output ..... 1V/300 ohms

max. output (0.5% T.H.D.) ..... 7V/300 ohms

CANNON JACK rated output ..... 1V/600 ohms

max. output (0.5% T.H.D.) ..... 5V/600 ohms

Harmonic Distortion (rated output, 20 to 20,000Hz)

RCA JACK output (at 1kHz, 0.003 AVE) ..... 0.008%

CANNON JACK output (at 1kHz, 0.005 AVE) ..... 0.01%

Frequency Response

RCA JACK (+0dB, -1dB) ..... DC~250,000Hz

CANNON JACK (+0dB, -1dB) ..... 10~250,000Hz

Hum and Noise (IHF, A network)

TUNER, AUX 1 (RCA JACK), AUX 2 ..... 95dB

TAPE MONITOR 1, 2 ..... 95dB

AUX 1 (CANNON JACK) ..... 83dB

RESIDUAL (volume level at min.) ..... 6µV, 100dB

Input Sensitivity/Impedance (ref. rated output)

TUNER, AUX 1 (RCA JACK), AUX 2 ..... 150mV ±1dB/50 kohms

TAPE MONITOR 1, 2 ..... 150mV ±1dB/50 kohms

AUX 1 (CANNON JACK) ..... 150mV ±1dB/600 ohms

Overload (1kHz, 0.5% T.H.D.)

TUNER, AUX 1 (RCA JACK), AUX 2 ..... 9V

TAPE MONITOR 1, 2 ..... 9V

AUX 1 (CANNON JACK) ..... 9V

Crosstalk (at 1kHz) ..... 80dB AVE

(at 10kHz) ..... 65dB AVE

Intermodulation Distortion (70Hz: 7kHz = 4:1) ..... 0.04%

## MIC AMPLIFIER SECTION (REF. PRE AMPLIFIER RATED OUTPUT)

Harmonic Distortion ..... 0.05%

Frequency Response (+0dB, -3dB) ..... 20~25,000Hz

Hum and Noise (IHF A network) ..... 70dB

Residual Noise (IHF A network) ..... 20µV, 100dB

Input Sensitivity/Impedance (LOW, HIGH) ±1dB ..... 4mV/600 ohms, 50 kohms

Overload (1kHz, 0.5% T.H.D.) ..... 1V

Crosstalk (at 10kHz) ..... 40dB

(at 20kHz) ..... 40dB

## HEADPHONES AMPLIFIER SECTION (REF. PRE AMPLIFIER RATED INPUT)

Harmonic Distortion ..... 0.05%

Frequency Response (LOW INP.) +0dB, -1dB ..... 50~50,000Hz

Hum and Noise (IHF A network) ..... 80dB

Power Output (MAX. 0.5% T.H.D. at 1kHz)

both channel driven 8 ohms load ..... 0.5W

both channel driven 600 ohms load ..... 0.35W

Output impedance LOW/HIGH ..... 4~16 ohms/600 ohms

Crosstalk (at 10kHz) ..... 40dB

Rated output (rated input) 1kHz

8 ohms load ..... 30mW

600 ohms load ..... 15mW

## CONTROL CHARACTERISTICS

Division Frequency ..... 32, 63, 125, 250, 500, 1000, 2000, 4000, 8000, 16000Hz/±12dB

Loudness 1 (at 50Hz/10kHz) ..... +13dB/+6dB

2 (at 50Hz/10kHz) ..... +7dB/+3dB

High Filter (at 12kHz) ..... 12dB/oct

(at 24kHz) ..... 12dB/oct

Low Filter (at 16Hz) ..... 12dB/oct

(at 4Hz) ..... 12dB/oct

Audio Muting ..... -20dB ±1dB

## MISCELLANEOUS

Power Requirements ..... 120V/60Hz or 220V/50Hz or 240V/50Hz  
or 100, 120, 220, 240V/50-60Hz  
(switchable)

Power Consumption ..... 60 Watts (Max.)

Dimensions (Overall) ..... 482(W) x 190(H) x 410(D)mm

Weight (Net) ..... 15kg

NOTE: Specifications and design subject to possible modification without notice.

OUTPUT vs TOTAL HARMONIC DISTORTION

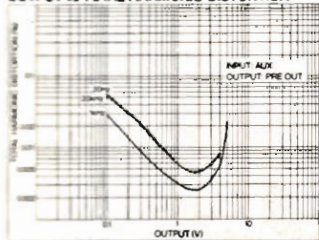

FILTER CHARACTERISTICS

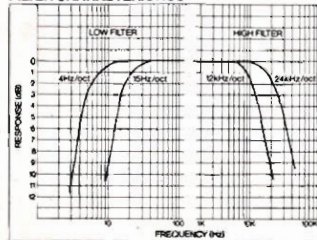

LOUDNESS (1)

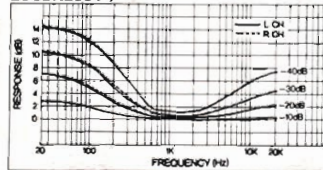

LOUDNESS (2)

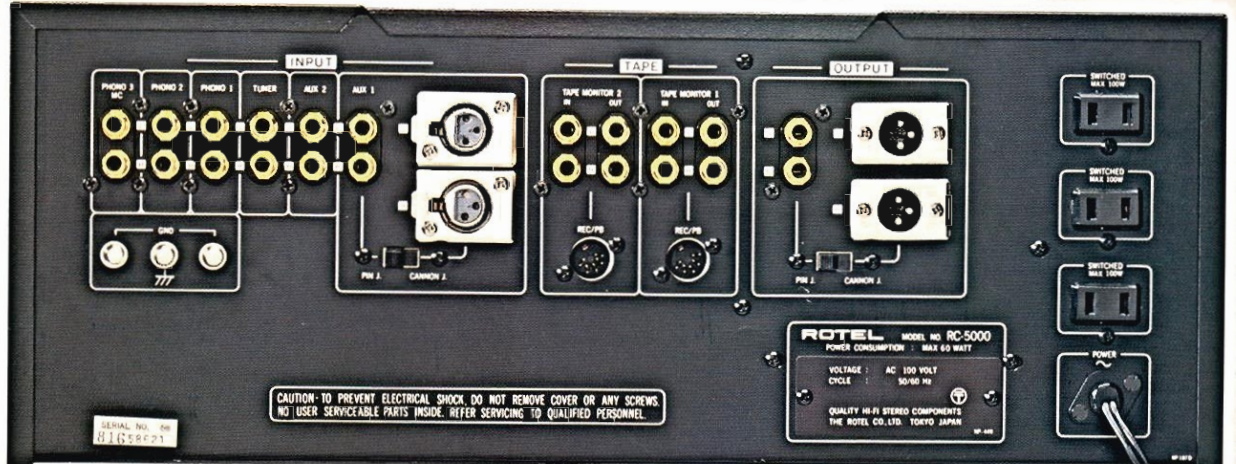
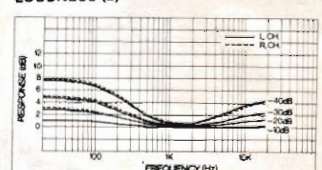

*The 5000series*



Quality. Uncompromised.

**ROTEL**